



SAFE IS THE NEW SMART



5MP Bullet Network Camera

Model: GNCA-IB5F05-WSB (Impact Series)



20 FPS



WDR 120dB



DUAL STREAM



H.265+

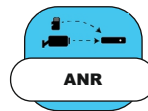

ANR



ONVIF



STARLIGHT



VCA



IP67



SMART IR



PoE



SD CARD



BUILT IN MIC.



SONY STARVIS

Application Areas



City Surveillance



Railway Station



Highways



Traffic Light



Airports



Crowded Public Places

Outdoor Fixed Bullet Camera

Featuring weather-resistant housing and easy to install design, GNCA-IB2F05-SB Globus Bullet Fixed Camera is ideal for wide range of outdoor surveillance purposes. This camera captures images in high definition and razor-sharp details.

Allowing users to capture video at a high maximum rate of 20fps, Globus Outdoor Bullet Fixed Camera provides a comprehensive and smooth surveillance to the property, without any compromise in quality.

Installation of Globus CCTV Cameras is simplified by their ultra-sturdy casing and equally rugged mounting arms. Its Plug & Play interface makes it more usable, manageable and convenient as compared to its conventional counterparts. For extra protection, the plastic casing comes with an inbuilt sunshade that further reduces glare coming from direct sunlight.

20 FPS



Frames per second, or fps, are the simple act of measuring how many video frames the surveillance camera captures per second of video. 20 fps means the camera captured 20 frames in a single second of video. If your storage or bandwidth is limited, a lower bandwidth of 20 fps will create smaller videos and prevent undue stress on your network. In many circumstances, a lower frame rate will still record video that is smooth while saving you space and bandwidth.

True Wide Dynamic Range

Globus Network CCTV Cameras are concocted with 120dB True WDR hence able to control the exposure as well as process the light values of each pixel in the image. Using 120dB WDR, the Globus range of cameras capture a balanced image with optimal exposure for all areas within the camera's field of view. In other words, Bright spots are toned down to prevent the image from being washed out, and the dark images are augmented to expose the objects in the shadows. This, in turn, enables the camera to go in places that would normally require expensive lighting controls/equipment.

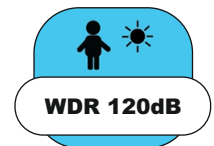

Dual Stream

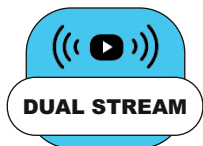

The feature of Dual Stream allows users to obtain two streams from a single camera at different resolutions, frame rates and codecs. It helps in a dual-display setup to view different streams at the same time, without consuming client-side bandwidth and processing power. This feature enables users to obtain outputs in accordance with the requirements of quality, storage constraints, bandwidth or CPU usage.

H.265+ Compression Technology

The optimized version of H.265 compression technology, it uses a scene-adaptive encoding technology, dynamic ROI, intelligent noise reduction, flexible multi-frame reference, etc. to deliver high quality images while utilizing lower bandwidth and storage space. It reduces the bit rate and storage requirements of the recorded videos by up to 70% as compared to its predecessor.



ANR Technology

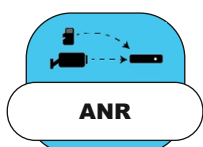

Globus Network Cameras support the Automatic Network Replenishment (ANR) feature i.e. if the connection between NVR and cameras is lost, the camera would start continuous recording and store videos in SD card instead of NVR. Then after reconnection, NVR automatically retrieves missed continuous videos from camera SD card in a period of time to prevent data missing. This feature enables user to use retrieve recorded data seamlessly and without any interruption. Thus, all of video recordings would be saved even network fails temporarily.

ONVIF STG



Globus Security Systems support ONVIF profiles S,T and G to ensure effective interoperability of our Network Cameras with other industry products. All our IP products are 100% ONVIF compliant and support all the features like video & audio streaming, pan-tilt-zoom control & relay output, site info & configuration, event & alarm management, etc

Starlight Technology

Powered by Starlight Technology, Globus Network Cameras are designed specifically to perform even under challenging lighting conditions. Our cameras offer astounding light sensitivity, colour rendition even in low light down 0.001 lux. It uses its optical features to balance light throughout the scene and produce coloured images in dark environments. Our cameras produce full colour images in the dark with utmost detail where most of the conventional counterparts switch to monochrome. Aided by Starlight technology combined with other impressive technical specifications, Globus Network Cameras are the ultimate 24x7 surveillance cameras in the market.



AI powered Video Content Analytics

The inbuilt AI-powered Video Analytics packs cutting-edge concepts and delivers more efficient, streamlined and hassle-free video assessment. It deploys artificial intelligence to cameras by analysing video content in real-time and fetches suitable inferences. It reliably detects, tracks and analyses object in its field of view and alerts users with preset alarms on incidents. A smart system of alarm rules out false alarms to minimum and makes surveillance from Globus Network Cameras more automated requiring minimal human intervention. Clubbed with features like Advanced motion detection, Camera tampering detection, People counting, Region entrance detection, Region departure detection, Line crossing detection, Loitering detection, Human presence detection, Left Object detection, Object removal detection, etc, Globus AI-Powered Video Analytics makes for a holistic and all-inclusive surveillance solution for every organization's security requirements.



IP67

Globus Network Cameras are resistant to mild physical strain and impact for performing rigorously even under harsh outdoor conditions. The IP 67 rating of our cameras certifies that they are built to withstand harsh weather conditions like dust, sunlight, rain, etc., making them perfect fit even in unforgiving conditions.



Smart IR Technology

Powered by Starlight Technology, Globus Network Cameras are designed specifically to perform even under challenging lighting conditions. Our cameras offer astounding light sensitivity, colour rendition even in low light down 0.001 lux. It uses its optical features to balance light throughout the scene and produce coloured images in dark environments. Our cameras produce full colour images in the dark with utmost detail where most of the conventional counterparts switch to monochrome. Aided by Starlight technology combined with other impressive technical specifications, Globus Network Cameras are the ultimate 24x7 surveillance cameras in the market.



Power Over Ethernet (PoE)

Power over Ethernet is an efficient way to power cameras with an Ethernet cord and also give them a direct network access. The functionality of PoE makes installation easier and cheaper by requiring only one cable. Unlike other connections, PoE also ensures your network cameras are always connected.

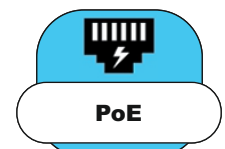

Edge based SD Card Recording

To increase its usability, Globus Network Cameras come with Edge SD Card Recording support. This feature also serves as a saviour during network or server burnouts.

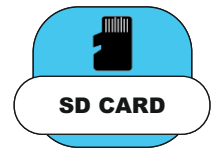

Built-In Microphone



The in-built microphone of Globus Network Camera facilitates glitch-free audio communication between operators and visitors. Recorded or live audios can also be used as an alarm system in case of specific incidents like perimeter intrusion, object removal, loitering, etc.

Sony Starvis Sensor

Globus Network CCTV Cameras are engineered with Sony Starvis Sensors, featuring back-illuminated pixel technology, these sensors are deemed to be one of the best-performing imaging technologies in the current market trends. Equipped with this sensor, Globus Network Cameras provide ultimate scenic detail, colour rendition and ultra-low-light performance with Prior Low Noise Circuit™ (PLNC) technology for better SNR. It features a sensitivity of 2000 mV or more per 1 μm^2 (color product, when imaging with a 706 cd/m² light source, F5.6 in 1 s accumulation equivalent) to render razor-sharp images with life-like detailing and colour reproduction. It deploys Multiple HDR filter to further increase the image quality.



5MP Bullet Network Camera

Camera	
Image Sensor	1/2.7" Progressive Scan CMOS
Effective Pixel	2592x1944
Min. Illumination	Color: 0.001Lux@F1.6, B/W: 0Lux with IR on
Shutter Speed	1s ~ 1/100000s
Lens	3.6mm Fixed Lens, Fixed Focus Control
Digital Zoom	16x Digital Zoom
Field of View	Horizontal: 81°
Aperture	F1.6
Iris Type	Fixed Iris
Signal System	PAL/NTSC
Adjustment Angle	3 Axis
S/N Ratio	>60dB
Day/Night	ICR Filter Auto Switch
IR Distance	Up to 50m
Wavelength	850nm
Video	
Video Compression	H.265+, H.265, H.264+, H.264
Streaming Capability	Dual Streams Individually configurable (H.265+,H.265,H.264)
Frame Rate	Main Stream: PAL: 20fps@2592 1944, 25fps@2592x1520, 2560x1440, 2304x1296, 1920x1080, 1280x720 NTSC: 20fps@2592 1944, 25fps@2592x1520, 2560x1440, 30fps@2304x1296, 1920x1080, 1280x720
	Sub Stream: PAL: 25fps@704x576, 704x288, 640x360, 352x288 NTSC: 30fps@704x480, 704x240, 640x360, 352x240
Video Bit Rate	16Kbps~16Mbps (CBR/VBR Adjustable)
Image	
Wide Dynamic Range (WDR)	120dB WDR
Back Light Compensation (BLC)	Supported
High Light Compensation (HLC)	Supported

Auto Exposure	Auto Level Control
Electronic Image Stabilization (EIS)	N/A
Privacy Masking	Supported (4 Areas, Rectangular)
ROI	N/A
Defog	Supported
Digital Noise Reduction	2D/3D DNR
Image Setting	Brightness, Contrast, Saturation, Sharpness, Image Rotation
Image Enhancement Function	AWB, AGC
Audio	
Audio Compression	G.711, G.711U, ADPCM
Audio Streaming	One-Way Audio
Audio Input	Built-in Microphone
Audio Output	N/A
Events	
Event Trigger	Motion Detection, Mask Alarm, IP Address Conflict
Video Content Analytics (VCA)	Tripwire, Perimeter
Local Storage	
Memory Card Slot	Supported up to 512GB Micro SD.
ANR	Supported, Auto store video in SD card when NVR is disconnected; Upload video to NVR when connection is resumed.
Alarm Interface	
Alarm Input	N/A
Alarm Output	N/A
Network	
Ethernet	1*RJ45 10M/100M Ethernet Port
IP Support	Static, Dynamic
Protocol	TCP/IP, HTTP, FTP, DHCP, DNS, DDNS, MULTICAST, IPV4, NTP, UDP, Telnet
AES Encryption	AES128 Supported
IP Address Filtering	Supported
Multi Level User ID/ Password	Supported

Network Storage	N/A
SIP/VoIP	N/A
Web Viewer	IE, Chrome, Firefox, Safari
Management Software Function	Globus CMS-lite
Mobile Application	GloView lite
System Compatibility	Onvif Profile S, T, G & SDK
User/Host	8
Environmental	
Power Supply	PoE (802.3af), DC 12V±10%
Power Consumption	6W Max, 7W Max(With IR on)
Operating Temperature	-40°C~65°C, Less than 95% RH
Ingress Protection	IP67
Vandal Resistance	N/A
Casing	Plastic
Dimensions	160.8mmX68mmX74.5mm
Weight	0.3Kg

Exploded View

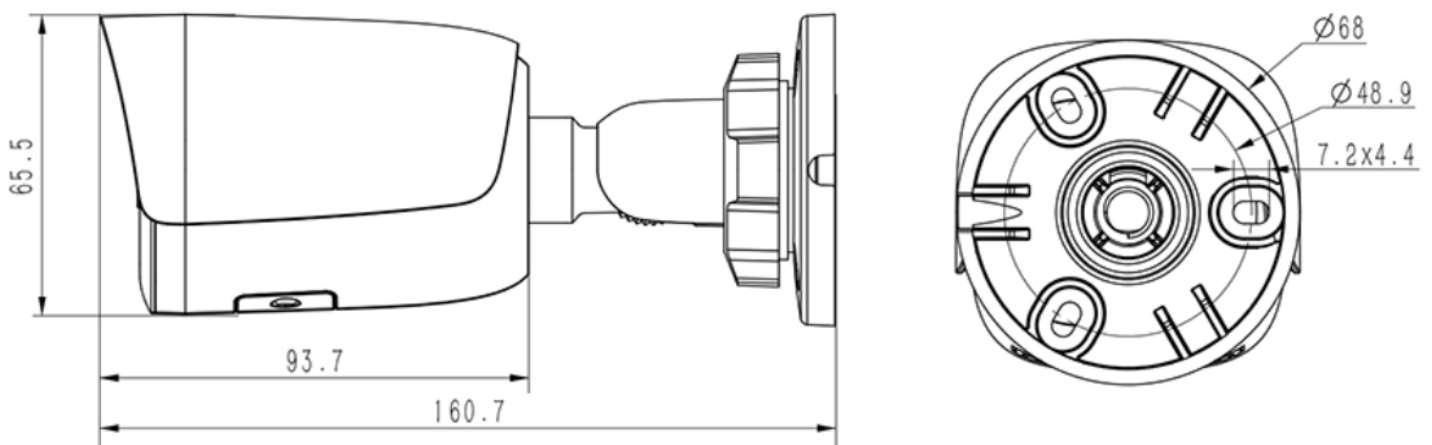

About Globus Infocom

Globus Infocom is a pioneer of technological solutions in the field of Education Technology, Collaborative Conferencing & Professional Displays, Security & Surveillance and Healthcare & Wellness.

The company houses one of the most elaborate range of security solutions including Network Dome Camera, Network Bullet Camera, PTZ Cameras, Fish Eye Cameras, NVRs, DVRs, Mobile Surveillance, Body Worn Cameras, Switches, PoE and related accessories.

With its in-house Research & Development team and the zeal for constant innovation, Globus has developed an insight to understand what 21st century Security & Surveillance market demands. Owing to its nationwide sales and service support, Globus Infocom, a proud Make in India brand, has amassed more than 25,000 customers with 50% of repeat order ratio.